

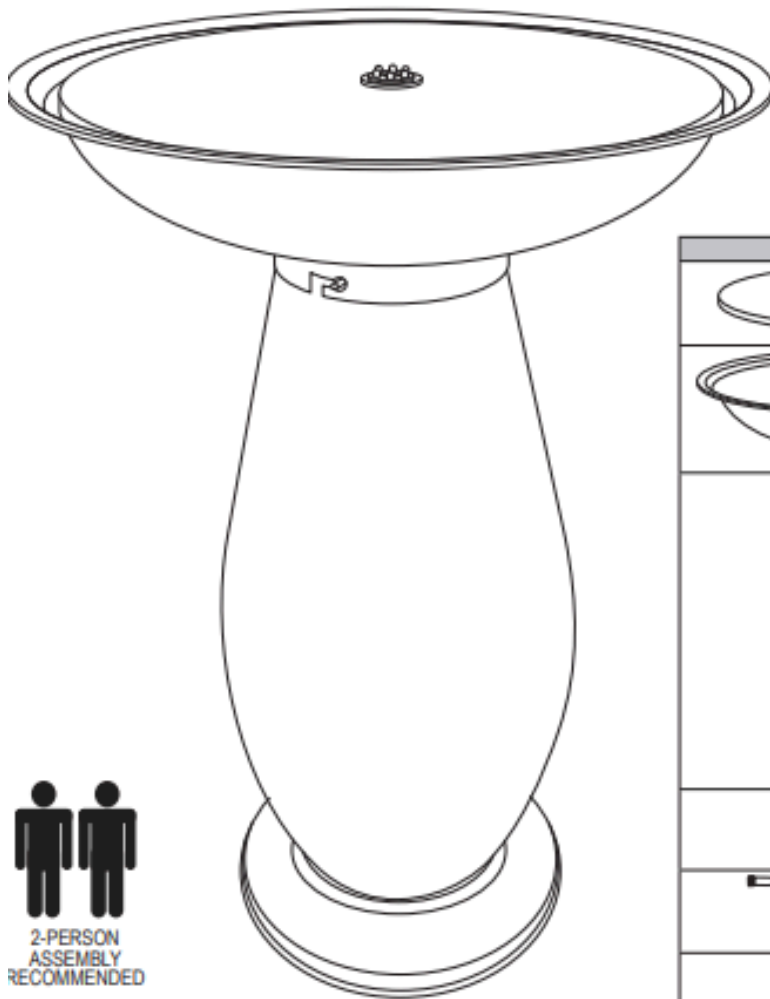







IRON CROSSHATCH BIRDBATH-STYLE FOUNTAIN QZC-328

Carefully review all assembly and care information before using this product. Save this manual for future reference.
Select a smooth, level surface to place the fountain. Assemble components on a soft, clean surface to avoid damaging the finish.

Inspect packaging to ensure all parts are accounted for before disposing of packing materials.
Save the packing slip.



PARTS		QTY.
	Topper	1
	Bowl	1
	Pedestal	1
	Electric Submersible Pump	1
	Light Splitter	1
	AC Adapter	1

IMPORTANT NOTES:

- The water tubing is built into the fountain topper. Take care when handling the water tube; detaching the tube from the topper will damage the fountain and void the warranty.
- Familiarize yourself with the flow control valve on the pump, maximum (+) and minimum (-). This may need to be adjusted to achieve optimal water flow.
- The light and light cable are rated for contact with water. Use care when handling the light, jarring movements or dropping the light may cause it to burn out prematurely.

ASSEMBLY



Assistance is recommended for assembly.

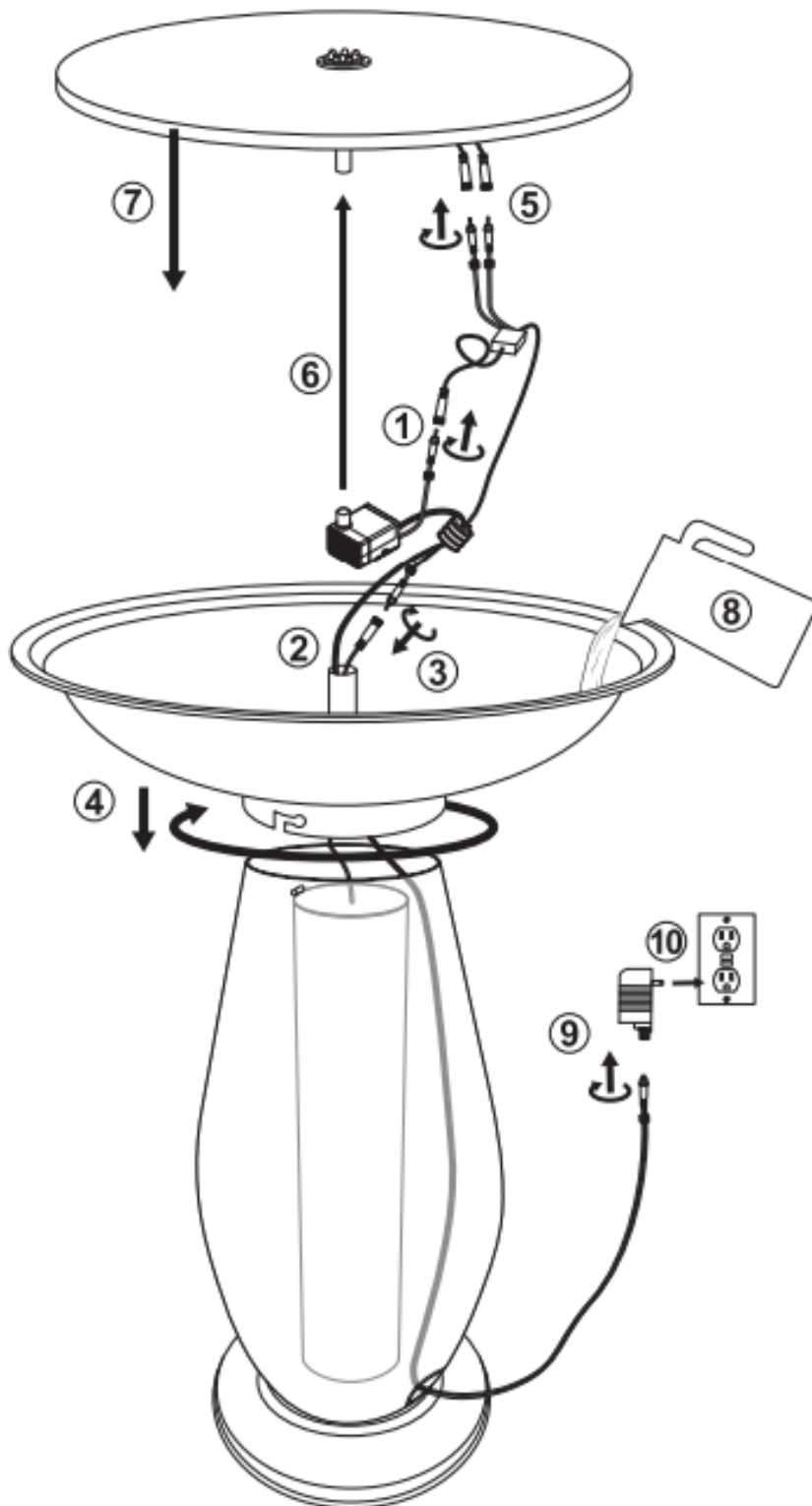

1. Connect the light splitter to the short pump cable. Place the pump in the bottom of the bowl.
2. Run the long pump power cable through the tube in the bowl, down through the inside of the pedestal, and out the opening at the base of the pedestal.
3. Locate the light cable inside the pedestal and securely connect it to the light splitter. Place the light splitter cable inside the rubber stopper on the pump power cord and insert the rubber stopper into the tube in the bowl. **NOTE:** The rubber stopper is a barrier to help prevent water leaking into the pedestal.
4. Ensuring the power and light cables do not get pinched, align the bowl with the pedestal and twist to lock them together.
5. Locate the light cables on the underside of the topper and firmly connect them to the light splitter.
6. Firmly connect the pump to the water tube on the topper; the connection will be tight.
7. Place the topper on the bowl.
8. Fill the base with enough water to keep the pump fully submerged during operation. **NOTE:** Ensure the water level does not exceed the height of the metal tube inside the bowl, the rubber stopper does not completely prevent water leaking.
9. Connect the adapter to the long pump cable.
10. Plug the adapter into a properly grounded GFCI outlet.

NOTE: When first used, there may be air trapped inside the pump. It may take several minutes for trapped air to escape, allowing water to flow. Refer to page 3 for more troubleshooting tips.

Care & Maintenance

- Some splashing may occur; adjust the flow rate on the pump if the water rate is too high. Do not use fountain in areas that can be damaged if water happens to splash or leak.
- Some climates and weather conditions increase water evaporation, requiring water to be added more frequently. Frequently check water levels during times of high temperatures, wind, and long-term exposure to direct sunlight to ensure the pump remains underwater. Never allow the pump to run dry as it will burn out the motor.
- Only use water in this fountain. Distilled water will help prevent mineral buildup but is not required. Tap water is okay to use, but avoid heavily chlorinated water as it may damage the fountain and the pump.
- Periodically change the water to help keep the fountain and pump clean. Remove scale and buildup regularly.
 - DO NOT use harmful additives such as bleach, chlorine, etc.
 - DO NOT use anything that is abrasive to scrub the fountain.
 - DO NOT use a pressure washer to clean the fountain.
- Always unplug the power supply before cleaning and maintaining the fountain and the recirculating pump. Take care when handling the pump; only pick it up by the body of the pump, never the power cord.
- During freezing weather, drain the fountain, disconnect the pump and store indoors; allowing ice to form may damage the fountain in such ways as, but not limited to, fountain cracking, permanent pump damage and/or lighting malfunction.
- Over time, the finish may gradually mellow in color due to sun exposure; this is part of the natural aging process and is not cause for return.

Troubleshooting

- If water is not flowing within several moments of the fountain being plugged in, ensure that the pump is fully submerged underwater. Add water to the reservoir if necessary. The pump may have air bubbles trapped inside, which can prevent water from circulating properly. Unplug the power supply for a few moments and plug it back in.
- Check the flow control on the body of the pump, it may need to be adjusted to achieve the desired water flow rate.
- Inspect the pump and tubing for obstructions.
- Pump noise can be caused by trapped air, low water level, or the pump being too close to the walls of the fountain. While the pump is fully submerged, try gently tapping the pump with your finger to help release the trapped air. Also, check if adding water or moving the pump helps to reduce noise.
- If water is not flowing and the lights do not turn on, ensure the AC adapter is fully connected to the pump power cable. If only the light is not working, ensure the cables are fully connected, and the seal is adequately tightened (do not over-tighten). Ensure the connector ends are completely dry before connecting and plugging the power cord back into an outlet.
- Check to make sure the power outlet is working; consult a certified electrician if in doubt about electrical connections.

If you experience issues with assembly or the product was damaged during shipping, please contact our customer service team through one of the methods mentioned at the top of page 1. Please have the item number and order information ready to expedite response time.

IMPORTANT SAFETY INFORMATION

- Keep fountain out of reach of children and pets.
- Make sure the power cord is away from traffic areas.
- Keep power cord away from all heat sources. Do not use electrical cords in areas with high temperatures.
- Check the water level frequently to ensure the pump remains fully submerged; never allow the pump to run dry as it will burn out the motor.
- Always unplug the power supply before cleaning and maintaining the fountain and the recirculating pump.
- Always empty and store the fountain and pump indoors during freezing weather.
- Do not use fountain in areas that can be damaged if water splashes or leaks.

Any modification to the product or failure to follow recommended care will void the product warranty.

WARNING:

Manufacturer and seller expressly disclaim any and all liability from personal injury, property damage or loss, whether direct or indirect, or incidental, resulting from the incorrect attachment, improper use, inadequate maintenance, or neglect of this product.

WWW.FOUNTAINS.COM